

Article number: 12318000050160

Description: KLEE-coil 318 000 050.160
M5 Hardened/zinc-plated slotted pin

Measures

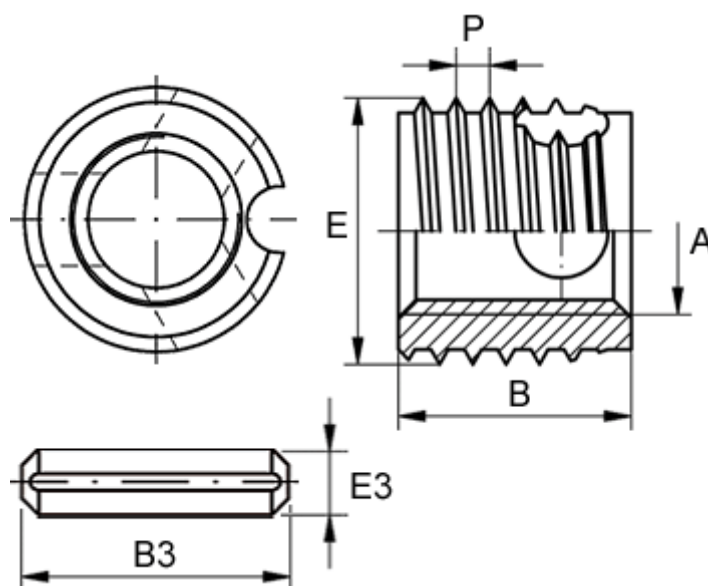

Female thread A	= M5
Length B	= 10
Male thread E	= 8.0
Min hole depth blind hole	= 13
Slotted pin B3	= 6
Slotted pin E3	= 2
Thread pitch P	= 1.00
Type	= 318 000 050 ...